

Katadyn Gravity Camp 6L  
(Model # 8019297)

Katadyn Base Camp Pro 10L  
(Model # 8019296)



EN

DE

FR

NL

DK

SWE

NOR

FIN

IT

ESP

POR

## Thank you for choosing a Katadyn portable water microfiltration system.

The Katadyn Gravity Camp 6L and Katadyn Base Camp Pro 10L Microfilters meet industry standards for reduction of bacteria (99.9999% *Klebsiella terrigena*) and protozoan cysts (99.9% *Giardia* and *Cryptosporidium*).

These products are designed to be used with untreated fresh water sources, such as lakes, rivers and streams. They are ideal for single persons or small groups while trekking or camping. These portable water filters are designed for the filtering of water only – never use it for any other purposes.

## KEY COMPONENTS

Bag, Filter, Cap with built-in Quick Connector, Hose, On/Off output hose valve

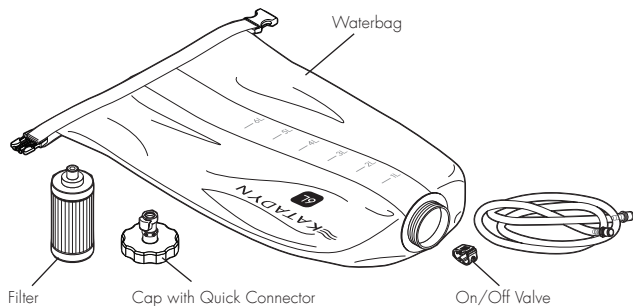

## HOW IT WORKS

The Katadyn Gravity Camp 6L and Katadyn Base Camp Pro 10L Microfilters utilize a cleanable filter protection sheet as a prefilter to extend the cartridge life and on a second step a 0.2 micron Ultra Flow Filter Technology™ pleated glassfiber cartridge to remove bacteria and protozoa like *Giardia* and amoeba as well as particles larger than 0.2 microns.

## WARNING

### IMPORTANT SAFETY MESSAGE

Read before using Katadyn Microfilter

- When you travel abroad, camp or backpack, you run a risk of illness ranging from the inconvenience and discomfort of diarrhea to more serious illnesses

caused by protozoan cysts (i.e., Giardia, Cryptosporidium), viruses and bacteria.

- The microorganisms that cause these diseases are often found in the food and water you consume. Lakes, streams and the local water supply may also be contaminated.
- To minimize the risk of contracting these illnesses, we suggest that you consult with your physician, state health department or travelers' clinic 4 - 6 weeks before you depart.
- And while you are traveling
  - Make sure that prepared food is thoroughly cooked to the following instructions.
  - Select non-cooked foods (fruits, nuts, etc.) that have intact shells or skins, and clean your hands before peeling the food.
  - Wash your hands with soap and warm water thoroughly and often, especially before you eat.
  - Filter all drinking water with your Katadyn Gravity Camp 6L Microfilter or Base Camp Pro 10L Microfilter, including water used for brushing teeth, washing your face, etc.

## WARNING

Improper use of this filter increases your risk of getting gastrointestinal illness. Read manual before assembling or using this water filter and follow all instructions. If you have any questions, contact Katadyn at +41 44 839 21 11 or email us at [customerservice@katadyn.ch](mailto:customerservice@katadyn.ch) or visit our website at [www.katadyn.com](http://www.katadyn.com).

Keep output hoses and other parts away from untreated water to prevent cross contamination.

If there is any risk of virus in the water, use a registered disinfectant such as Micropur Forte Tablets as post treatment, boil your water or use 4 drops of ordinary household bleach.

## PRODUCT SET-UP

The Camp Microfilters require minimal set up. For best results, try out the products before first use and familiarize yourself with their operation.

## 1. Install Filter Protector (pre-assembled)

The Filter Protector is a cleanable screen that covers the Ultra Flow Filter™ Cartridge. A frequent cleaning is not required; however, using the Filter Protector will extend the life of your cartridge.

It may be used continually or when source water contains suspended particulates or dirt.

Step 1: Wrap protector sheet around cartridge (there will be approximately a 5 cm overlap) and hold in place.

Step 2: Slip the flexible netting over the cartridge. Adjust filter protector sheet and netting so they are positioned evenly. (Figure 1)

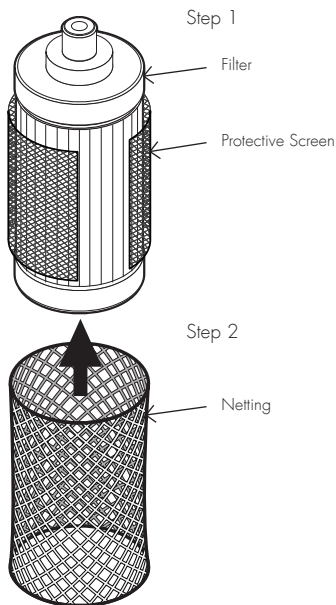

(Figure 1)

## 2. Install Filter

Screw cartridge clockwise inside cap as far as it will go. Do not grasp the cartridge around the pleated surface, since it may damage the filter. Screw the cap clockwise on the external threads of the bag as far as it will go. Connect the output hose to cap by pushing the connector at hose into the cap connector until it clicks in place. (Figure 2)

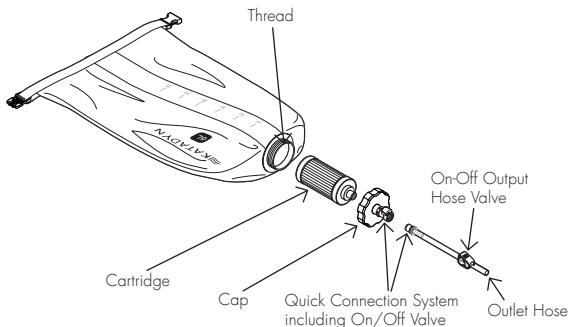

(Figure 2)

## 3. Flush System (Important!)

Before first use, flush system by running approximately 2 liters of water through the unit to remove harmless particles and dust. See following section on Normal Operation on how to filter water.

### **⚠ WARNING**

Improper threading of filter cartridge to cap could cause fluid leakage and result in illness.

Follow instructions for proper installation of the cartridge. A damaged and contaminated filter could expose you to harmful microorganisms and result in illness.

- Always handle filter carefully.
- If filter has been dropped into contaminated water source, follow instructions for storage to completely disinfect hoses and filter before use.
- If filter is damaged or contaminated, do not use.

## NORMAL OPERATION

1. Ensure filter cartridge is properly tightened into the bag (per Product Set Up instructions).
2. Remove output hose from the cap by disconnecting the quick connection system. As long as the output hose is not attached to cap, the integrated quick connection valve closes the quick connect valve, turning off the water flow. Once output hose is reconnected, the quick connection valve will be opened and water will begin flowing.

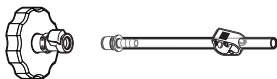

3. Fill bag with water using a separate container. If a separate container is not available, open bag and fill directly from water source. Do not allow contaminated water to contact outlet connection or end of outlet hose. **IMPORTANT** (to avoid the risk of illness): Dry off outside of bag and outlet hose to avoid untreated water running down bag/hose into your water container.

### WARNING

To minimize the risk of illness, dry off outside of bag and outlet hose to prevent untreated water from running down bag/hose and into your water container. Improper use of filter can lead to contamination and illness. To minimize risk, when filtering water, do not splash dirty or unfiltered water into clean container and follow all of the instructions in this manual.

4. Close bag by folding ends. (Figure 3) Dry bag and outlet connector with clean cloth.

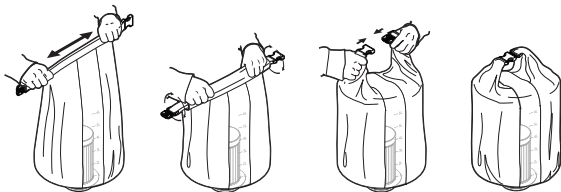

(Figure 3)

5. Elevate bag in convenient location. For best flow, position the filter in an upright position and hang from the highest possible location. (Figure 4)

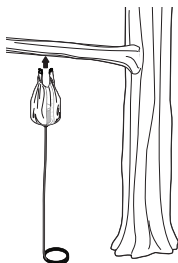

(Figure 4)

6. Close the output hose valve. Connect the output hose to the connector at the cap (this will initiate water flow into the output hose). Open hose valve clamp to begin water flow. Close hose valve clamp to stop water flow. Ensure hose valve clamp is in wide open position (not pinching hose whatsoever) while filtering to ensure maximum flow rate.

## FIELD PERFORMANCE TIPS

This product is designed to remove bacteria and protozoan cysts such as *Giardia* and *Cryptosporidium* from water. To extend cartridge life, always use the best available water source along with the Filter Protector. Read **WARNING** on the end of the manual before using this product.

**Maintain your Katadyn water system to keep it operating properly.**

### 1. If Water Flow is Slow

**Check Outlet Hose:** Ensure outlet hose valve clamp is in the wide open position, not pinching the hose whatsoever. Ensure outlet hose quick connect is securely connected to the quick connect on the cap or water will not flow into outlet hose.

**Clogged cartridge:** A clogged cartridge requires cleaning and may require replacement. As a solution in the field, screw cap counterclockwise from the bag to expose the filter cartridge and remove cleanable Filter Protector. Clean Filter Protector by placing it on flat surface and clean with damp sponge or fabric. Next, swish cartridge in water to remove any built-up sediment. Hold at quick connector to avoid submerging the filter in untreated water. If flow

is not restored to desired level, replace cartridge with new Ultra Flow Filter Cartridge.

Clogged Outlet valve: Unscrew cap counterclockwise from the bag. Then screw the filter counterclockwise out of the cap. Swish cap in water to remove any sediment from connection.

Add the output hose and flush the cap and the hose with clean water. If clean water is unavailable, flush the system with the first liter of treated water when you start filtering water again.

## 2. If System Leaks Near the Cap

Defective or missing seal: Unscrew cap counterclockwise from the bag. Check if the white seal is still in place and not damaged. If not replace it (Figure 5).

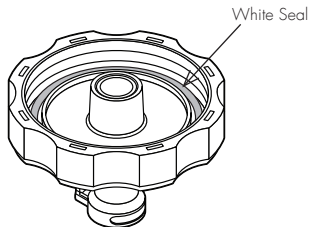

(Figure 5)

## LONG TERM STORAGE (AFTER YOUR TRIP IS OVER)

Disinfect your microfilter before storage to prevent microbiological growth within the cartridge.

1. Fill a 2 liter container with tap water and add 4 Micropur MP1 Purification Tablets or Micropur Forte MF 1T. (If not available use 4 drops of ordinary household bleach.)
2. Pour solution into water bag.
3. Hang bag and allow the entire amount of solution to run through cartridge (into sink or container) to disinfect filter, hoses, bag, etc.
4. Unscrew the filter cartridge and cap. Remove the filter protector and flush all parts with clean water.
5. Allow the components to air dry completely before reassembling the filter.
6. Store all dry components inside the carry bag.

Note: When removing unit from long-term storage, flush the system with 2 liters of water to remove any stale tasting water.



## WARNING

Before long-term storage, disinfect filter thoroughly to prevent growth of mold, mildew and bacteria which could cause illness.

Do not use dishwasher or microwave to disinfect parts. Doing so will damage or melt the parts from high heat.

EN

## FILTER CARTRIDGE CAPACITY & REPLACEMENT

Cartridge capacity depends on water quality. To extend cartridge life, use filter protector and clean it regularly. The Katadyn Gravity Camp 6L and Base Camp Pro 10L were tested and found effective for removal of bacteria and protozoan cysts like Giardia and Cryptosporidium. To keep the filter cartridge performing at a high level, it should be replaced after 1500L or if water flow has stopped (review Field Tips to ensure best product performance).

### Replacement Cartridge Installation

Replacement cartridges (Ultra Flow Filter Cartridge) are available from the dealer where you purchased your Katadyn Gravity Camp 6L or Katadyn Base Camp Pro 10L. Both the Gravity Camp 6L and Base Camp Pro 10L will allow a Hiker Pro Replacement Cartridge or Siphon Ceramic Microfilter Element to be used as well (see sections in this manual for installation instructions). A manual is included in the packaging of the Hiker Pro Replacement Cartridge or available in the download area of [www.katadyn.com](http://www.katadyn.com).

To replace the Ultra Flow Filter Element:

1. Remove output hose and unscrew cap. Screw the cartridge counterclockwise to remove. Do not grasp the cartridge around the pleated surface, since it may damage the filter.
2. Rinse the inside of water bag with clear water (non-filtered water is ok). Discard water. Wipe inside of water bag with soft cloth to remove sediment.
3. Insert new cartridge as described in Product Set-up step 2 (See Figure 2).

## KATADYN HIKER PRO REPLACEMENT CARTRIDGE COMPATIBLE

The **Katadyn Hiker Pro Replacement Cartridge** (sold separately) is also compatible with the Gravity Camp 6L or the Base Camp Pro 10L. This allows customers who own the Hiker, Hiker Pro or old Base Camp to use the same cartridge in multiple products. The Hiker Pro Replacement Cartridge has a carbon core which improves

the taste of the water and reduces chemicals.

(Note: the flow rate will be slower than the Gravity Camp 6L and Base Camp Pro 10L filter due to the carbon core - approximately 0.5 l per minute)

### **Install Filter Cartridge**

Press cartridge into external threaded opening of bag until the o-ring can no longer be seen. This may require some effort. A small amount of food grade, water resistant multipurpose grease for rubber-elastic seals and plastic bearings (e. g. BERUSIL FO 26) or Katadyn silicon grease on the cartridge o-ring will aid the insertion.

Do not grasp the cartridge around the pleated surface, since it may damage the filter. Attach threaded cap (sold separately) to the external threads of the bag and turn clockwise to hold the cartridge firmly in place. Attach output hose to cartridge output barb (Figure 6).

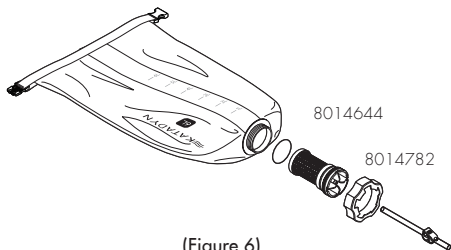

(Figure 6)

## **KATADYN SIPHON CERAMIC MICROFILTER COMPATIBLE**

The Katadyn Siphon Ceramic Microfilter (sold separately) is also compatible with the Gravity Camp 6L or the Base Camp Pro 10L. Some customers prefer the benefits of our long lasting, cleanable ceramic filters. They are excellent for extremely dirty/silty water, although the flow rate of the Siphon Ceramic Filter is slower than the standard pleated filter in the Gravity Camp 6L and Base Camp Pro 10L (approximately 0.5 l per hour).

### **Installing Siphon Ceramic Filter Cartridge**

Screw the cap clockwise on the external threads of the bag as far as it will go. Screw cartridge clockwise inside cap as far as it will go. Connect the output hose to cap by pushing the connector at hose into the cap connector until it clicks in place (Figure 7).

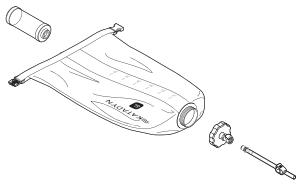

(Figure 7)

## CAMP SERIES ACCESSORIES

**Shower Adaptor Accessory** (sold separately) - quickly and easily converts your Gravity Camp 6L or Base Camp Pro 10L into a shower. Remove the filter and cap from your Gravity Camp 6L or Base Camp Pro 10L and install the Shower Adaptor Cap in its place (Figure 8). Simply turn the window of the bag toward the sun to warm up the water inside the bag prior to your shower. Always test the water before showering to ensure it is not too hot.

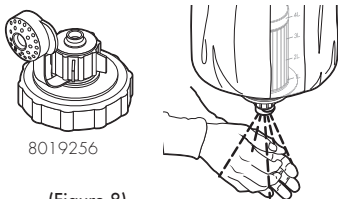

(Figure 8)

**Carbon Cartridge Post Filter** (sold separately) - The carbon cartridge helps improve the taste of the water and reduces chemicals. The Carbon Cartridge is easily attached to the end of the output hose and acts as a bottle adaptor for wide and small mouth water bottles and hydration bladders (Figure 9). It can also be added in-line by splicing the output hose and installing the Carbon Cartridge anywhere along the length of the output hose.

**IMPORTANT!** Before first use, flush the Carbon Cartridge to remove harmless carbon dust from the Post Filter. Fill bag with water. Connect the output hose valve with the assembled cartridge to the connector at the cap. Open hose valve clamp to begin water flow. At the beginning the water will be black from the carbon dust. This is normal when flushing. Flush until the water is clear, but at least for 2 liters.

(Figure 9)

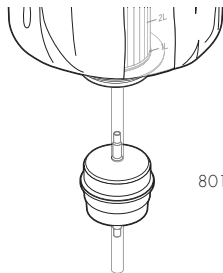

8013450

## PRODUCT REGISTRATIONS & SPECIFICATIONS

### PRODUCT REGISTRATION

Please take a moment to register your new Katadyn product by completing the short product registration form online at [www.katadyn.com/productregistration](http://www.katadyn.com/productregistration). The information you provide will enable us to better serve you with products developed to meet your needs and interests.

Register your Katadyn product online and you will be automatically entered into a drawing to win a free Katadyn product. We will keep you informed of new products from Katadyn, Optimus and our dehydrated food brands (see our website for more details).

### PRODUCT SPECIFICATIONS

Kit Contains:	Gravity Camp 6L or Base Camp Pro 10L water bag with clear window and water level marks Ultra Flow Filter Element 0.2 micron water filter with cleanable filter protector Filter Cap with On/Off quick connect valve Output hose Black quick connect to connect output hose to Filter Cap White quick connect to connect to hydration systems Black hose clamp shut off valve Output hose bag Storage bag Sponge for easy cleaning
---------------	--

Flow Rate:	Up to 2 l of water per minute
Filter Capacity:	Up to 1,500 l, depending on water quality
Gravity Camp 6L Weight:	290 g
Dimensions:	25 x 15 x 6 cm / 10 x 6 x 2.4 in
Base Camp Pro 10L Weight:	350 g
Dimensions:	27 x 15 x 7 cm / 10.6 x 6 x 2 in

## PRODUCT WARRANTY

### AntiClog™ GUARANTEE

#### ONE-YEAR FULL WARRANTY ON ULTRA FLOW FILTER CARTRIDGE

**What is covered:** Katadyn warrants your Ultra Flow Filter Cartridge to be free from defects that cause the filter to clog as long as the product is used only with untreated fresh water sources, such as lakes, rivers and streams.

**How long does the coverage last:** One year from the date you purchased your Gravity Camp 6L or Base Camp Pro 10L Water Filtration System.

**What Katadyn will do:** If your filter clogs or you are unhappy with its flow rate during the one-year full warranty period, Katadyn will send you a replacement Ultra Flow Filter Cartridge free of charge.

### LIMITED WARRANTY

#### 2 YEAR LIMITED WARRANTY ON REMAINDER OF GRAVITY CAMP 6L OR BASE CAMP PRO 10L WATER FILTRATION SYSTEM

**What is covered:** The remainder of your Gravity Camp 6L or Base Camp Pro 10L Water Filtration System is warranted to be free from defects in materials and workmanship. This warranty is extended only to the original end-use purchaser or the person receiving the product as a gift, and shall not be extended to any other person or transferee.

**How long does the coverage last:** Two years from the date you purchased your Gravity Camp 6L or Base Camp Pro 10L Water Filtration System.

**What Katadyn will do:** In the event of a defect in materials or workmanship within the Two-Year limited warranty period, Katadyn will either repair or replace your Gravity Camp 6L or Base Camp Pro 10L Water Filtration System, at Katadyn's discretion.

**What Katadyn will not do:** Pay shipping, insurance or transportation charges from you to Katadyn, nor any import fees, duties and taxes.

## **WHAT THE KATADYN PRODUCT WARRANTY DOES NOT COVER**

The remedies provided in Katadyn's One-Year Full Warranty and Two-Year Limited Warranty shall be the user's exclusive remedies for all claims arising from the purchase, use or performance of Katadyn's Ultra Flow Filter Cartridge and Gravity Camp 6L or Base Camp Pro 10L Water Filtration System, including claims for non-conforming or defective goods. Katadyn expressly disclaims and excludes from its warranties, and shall not be responsible for, any incidental or consequential damages arising out of the purchase, use or performance of its Ultra Flow Filter Cartridge or Gravity Camp 6L or Base Camp Pro 10L Water Filtration System.

## **WHAT YOU SHOULD DO TO GET COVERAGE**

To receive coverage under Katadyn's Product Warranty, please return your Ultra Flow Filter Cartridge or Gravity Camp 6L or Base Camp Pro 10L Water Filtration System to the retailer from whom it was purchased for repair or replacement. If you are not completely satisfied with the service you receive from your retailer, call Katadyn Customer Relations for service assistance. Please retain purchase receipt as proof of date purchased. This limited warranty gives you specific legal rights and you may have other legal rights, which may vary from state to state or country to country.

## **CONTACT INTERNATIONAL**

Katadyn Products Inc.  
Pfäffikerstrasse 37  
8310 Kempthal  
Switzerland  
Phone: +41 44 839 21 11  
customerservice@katadyn.ch

Log on to our website to learn more about our full line of products including Katadyn, Optimus Stoves and Trek'n Eat Foods.

[www.katadyn.com](http://www.katadyn.com)  
[www.optimusstoves.com](http://www.optimusstoves.com)  
[www.trekneat.com](http://www.trekneat.com)



Contact International  
Katadyn Products Inc.  
Pfäffikerstrasse 37  
8310 Kempthal  
Switzerland  
Phone: +41 44 839 21 11  
[customerservice@katadyn.ch](mailto:customerservice@katadyn.ch)